

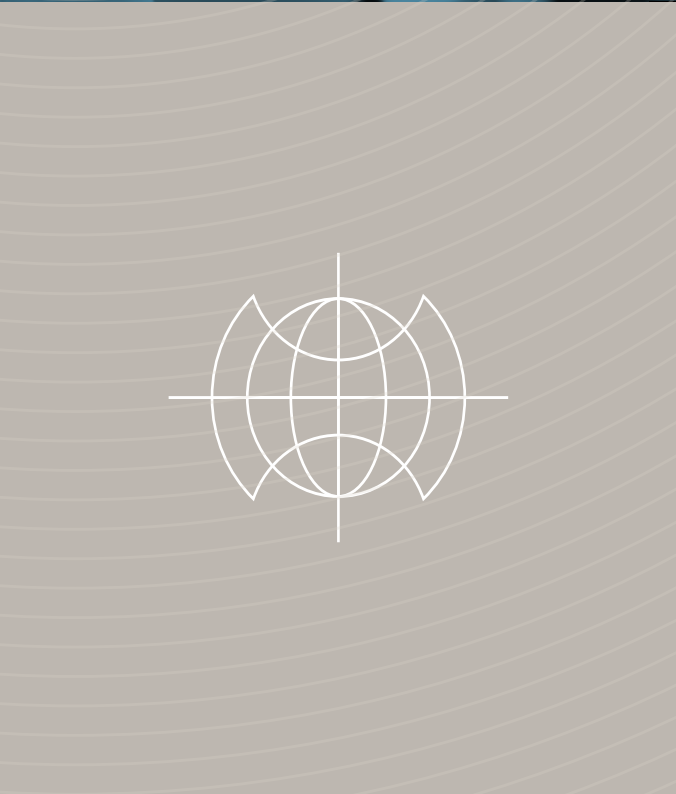

Plastics

Injection Moulding, Blow Moulding, Recycling



About BUNTING

Bunting is an industry leader in the design, manufacture, and sales of cutting-edge magnetic equipment used in applications such as magnetic separation, metal detection, conveyor systems, custom manufactured magnets, and more. All of the products we sell are custom-designed by our engineering team. We work with customers to determine their exact needs and develop a product that will perfectly suit the challenges of the industry they are working in and the materials they are handling, as well as being designed to fit within the existing layout of the customer's facility.

Since 1959, Bunting has been a family-owned, family-operated company. Headquartered in Newton, KS, Bunting currently has multiple branches within the United States as well as abroad in the United Kingdom. We are committed to upholding the all-American values of innovation, dedication, and hard work that Bunting was founded upon sixty years ago.

As technology continues to advance across every industry, Bunting remains committed to integrating new technology into our products, creating solutions that address modern industry challenges, and continuing to expand our domestic and international reach.

Bunting-Newton primarily focuses on magnetic equipment for magnetic separation and metal detection applications. Newton, Kansas has served as the company's headquarters since 1979. Here, we design and manufacture magnetic separation, metal detection and material handling equipment as well as a complete line of printing cylinders. With a team of engineers using world-class, computer-aided design equipment, we can customise and develop products to fit any application or production line.

Bunting-DuBois has a unique role as it is the only North American manufacturer of compression bonded, injection moulded, and hybrid magnets used in custom designed permanent magnet assemblies. These assemblies are used in the military, aerospace, automotive, and other industrial commercial industries.

Bunting-Elk Grove Village is home to the company's Magnet Materials division. Bunting-Elk Grove Village provides the largest online selection of permanent magnets and magnetic equipment, with all in-stock items able to be shipped within 24 hours of an order being placed on its website, BuyMagnets.com.

Bunting-Berkhamsted provides total magnetic solutions—from individual magnets and magnetic sub-assemblies to magnetic separation, material handling, and metal detection equipment to various industries throughout Europe and the UK. Bunting-Berkhamsted also manages e-magnetsuk.com, where customers may purchase a wide variety of commonly used magnets.

Bunting-Redditch provides a complete line of magnetic separation, recycling, and metal detection equipment to industries across the globe through a worldwide network of distributors.



Bunting®

Magnetic Technology for All Industries

The unique benefits of magnetic technology can be utilised across a wide range of applications, and Bunting is always looking to the future regarding new challenges that present themselves in the many industries we work with. Bunting engineers are constantly working to develop new technologies and improve upon our existing product lines. Bunting custom designs, manufactures, and distributes a broad selection of magnetic separation and metal detectors for the following general sectors:

FOOD AND PHARMACEUTICALS

PLASTICS

RECYCLING

AUTO SHREDDING

AGGREGATE, MINING, AND MINERALS

CERAMICS

TEXTILES

METAL STAMPING & FABRICATING

PRINTING, DECORATING AND CONVERTING

CUSTOM MAGNETS AND MAGNETIC ASSEMBLIES

STOCK MAGNETS & MAGNETIC TOOLS

Across all the industries Bunting works with, our commitment to providing quality products and customer service remains consistent. Bunting enthusiastically offers custom designed applications for customers bringing unique challenges to the table, and we take pride in working individually with each customer in order to provide the best product possible.



Contents

Magnetic Separation.....	7
FF Drawer Magnets.....	8-12
HF Drawer Magnets.....	13
Cartridge Magnets.....	14
Turbo Grate	15
Plate Magnet	16
Plate Housing Magnets	17
Suspended Plate Magnets.....	18
Hump Magnets.....	18
Wedge Magnets.....	19
Drum Magnets.....	19
Standard Drum Magnets	19
Pneumatic In-Line Magnets.....	20
Centre-Flow Magnets	20
Gravity In-Line Magnets.....	21
Torpedo In-Line Magnets	21
Magnetic Pull Test Kits	22
Metal Detection.....	23-24
Electronics for Metal Detection Equipment	25
Metal Detectors for Plastics Recycling	27
(quickTRON™ 03R, quickTRON™ 05, HS 9050/9100, MMS)	
Web Detection Metal Detector	28
(profiLINE™ 04/05, profiLINE™ 05)	
Pneumatic Conveying Metal Detectors	29
(pTRON™ 03, pTRON™ 05 & 07)	
Metal Detectors for Conveyors.....	30-31
(meTRON™ 03 SL, meTRON™ 05 VT, meTRON™ 05 D, meTRON™ 05 S)	
Tunnel Style Metal Detectors	31-32
(meTRON™ 05 & 07 CI, meTRON™ 07 CI with Conveyor)	
Cleaning Systems	33
(Duplex Separator, By the Press Cleaning Station, Gaylord Cleaning Station)	
Metal Detection Service	34
Metal Detector Warranty Solutions.....	35
Conveyors and Conveyor Components	36
Parts Handling Move-It™ Conveyors	37-38
Grinder, Shredder, Feeder, and Discharge Conveyors.....	39-41
Recycling Conveyors	42
(Bale Break Stations)	
DragSlide Conveyors	43
HISC™ High Intensity Separation Conveyors.....	44
Magnetic Separation Pulleys	45
Magnetic Crossbelt Conveyors	45
Eddy Current Separator	46
Perfect Plants	48-49

Permanent Magnets:

Permanent magnets are essential to virtually every type of modern technology and convenience. Being able to provide the optimum magnetic solution to the customer requires in-depth knowledge of the full supply chain. Bunting's team of magnet experts and engineers is fully equipped with this knowledge. Bunting entered the magnetics industry in 1959 as a magnet distributor and rapidly grew to a manufacturer of magnetic products, focused on custom design and customer-focused engineering. Today, Bunting is a leader in manufacturing and designing a diverse range of innovative magnetic technologies across industry sectors. Listed below are the general permanent magnet types that are used in Bunting products.

Neodymium Iron Boron Magnets

Neodymium magnets are a type of rare earth magnet and are the most common rare earth permanent magnets in the world. They are composed of Neodymium (Nd), Iron (Fe) and Boron (B), and exhibit the highest maximum energy product of any permanent magnet material. However, these magnets are vulnerable to corrosion if they are exposed to the elements. To protect the magnet from corrosion, the magnet is usually coated with nickel. Other coating options are aluminium, zinc, tin, copper, epoxy, silver and gold.

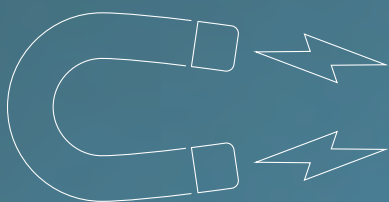

Plastic Bonded Neodymium Magnets

These magnets are cost effective while offering high performance and tolerances in addition to low electrical conductivity. It is possible to multipole magnetise them as a complete ring, and they can be designed to achieve specific flux density profiles. These are especially well suited for applications such as minimising cogging torque in motors. These injection moulded magnets are an excellent choice for higher volume applications. Compression bonded magnets can also be easily machined, making them suitable for low volume production in manufacturing magnets with multipole magnetisation, skew angled poles, and various other directions of magnetisations. Magnetising patterns are only limited by whether or not a magnetising coil fixture can be produced to give the required magnetising pattern.

- Bonded NdFeB magnets can be compression or injection moulded to final shape. These high tolerances can be achieved without the need for further machining.
- Injection moulded magnets are available in both neodymium and ferrite varieties.
- Injection moulded ferrite magnets offer high durability and resistance to shock, as well as a low cost and extreme resistance to corrosions and conditions such as low density.
- Available in high tolerance and complex shapes.
- No coating required, although black epoxy and Parylene coatings are available.

Samarium Cobalt Magnets

Samarium cobalt magnets are rare earth magnets that offer high maximum energy products and can operate in high temperature environments. They are extremely strong and typically allow for smaller size magnet profiles. Though not as strong as neodymium magnets, samarium cobalt magnets present three significant advantages. They work over a wider temperature range, have superior temperature coefficients, and also have a greater resistance to corrosion. Special coatings are available for specific marine and automotive applications.

Samarium cobalt magnets are one of the most useful magnets for high temperature applications. They retain most of their energy up to 300°C, making them ideal replacements for Alnico magnets when high temperature use or miniaturisation is required. Samarium cobalt magnets are known for their excellent temperature stability—maximum use temperatures are between 120 and 290°C; Curie temperatures range from 370 to 420°C.

Ceramic

Ceramic magnets, or ferrite magnets, are low cost, lightweight, moderate energy permanent magnets capable of withstanding operating temperatures of up to 250°C. They are highly corrosion resistant and work well in high volume applications. Ceramic magnets can be made in many shapes and sizes, can be ground to intricate and accurate shapes, and can even be designed to be small enough to be used in micro applications.

Alnico Magnets

Alnico magnets are alloys comprised of aluminium, nickel, iron, and cobalt. They have the highest operating temperature and temperature stability of any permanent magnetic material. They retain approximately 85% of room-temperature magnetisation at temperatures of up to 500°C. They possess high residual induction as well as relatively high energies. Alnico magnets naturally possess an excellent corrosion resistance.

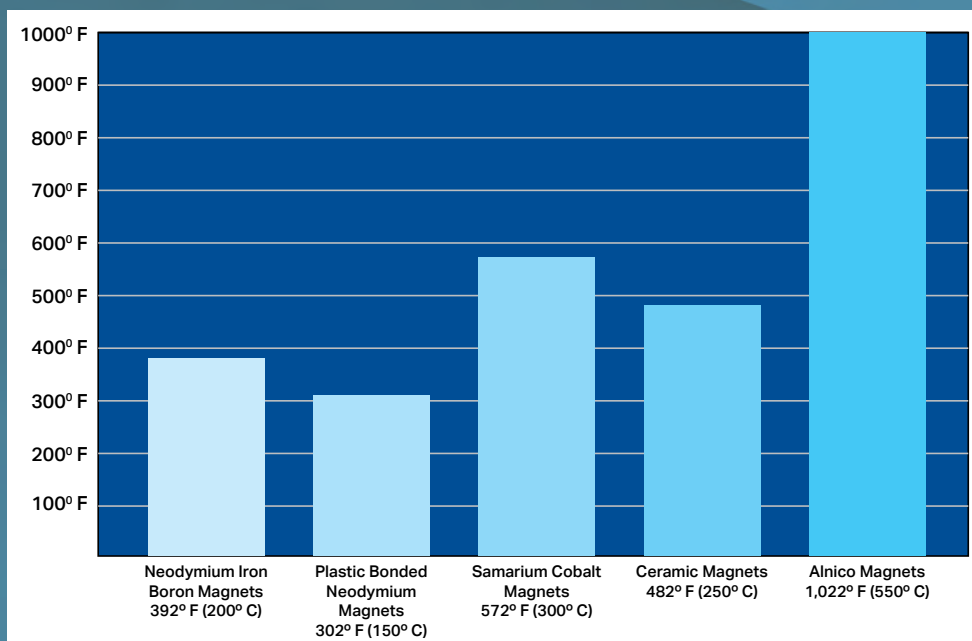

MAGNETIC SEPARATION

Safeguard your product quality and protect your processing equipment with Bunting® magnetic separation products. Separation of metal contaminants is an essential step in the production of plastics. Bunting manufactures an extensive line of magnetic separation equipment that removes contaminants from a variety of material consistencies. We offer units designed to remove metal contamination from gravity, mechanical, and pneumatic conveying systems.

Metal contaminants in a production line present not only a risk to a consumer who

may be harmed by a sharp piece of scrap metal, but also to the other equipment in your facility. Our magnetic separation equipment pulls contaminants out of the production line quickly and efficiently, sparing you the costs of repairing or replacing equipment such as grinders that could be seriously damaged if a piece of metal scrap were to pass through them. In addition to causing harm to the consumer and to other equipment within a facility, metal contamination being found in a product can seriously damage a manufacturer's brand and reputation.

Gravity Free-Fall Style Magnetic Separation



NEO FF SERIES DRAWER MAGNETS

Superior Contaminant Capture that Handles High Temperatures

Since 1964, Bunting® Drawer Magnets have been the plastic industry's most popular choice for extrusion, injection, and blow moulding equipment. Today, they are better than ever. Our FF Series Drawers come standard with super-strong neodymium rare earth magnets powerful enough to capture and hold ferrous particles so small that they are invisible to the naked eye. NEO magnets have exceptional surface holding force for more complete removal of contaminants and less chance of "wipe-off," (which refers to contamination falling off of the magnetic surface and re-entering the product stream).

Durable Construction

Bunting NEO FF Drawer Magnets feature rugged 11-gauge stainless steel housings built to support symmetrical compression loads of 10,000 lbs. The drawer gasket on these magnets are cut from Ethylene Propylene Diene (EPDM), which resists heat aging, is compression set, and is much more durable than sponge rubber.

- The NEO FF drawer utilises temperature-compensated rare earth magnets for up to 150° C temperature operation.
- Units are built with welded stainless steel housings for easy cleaning and durability.
- EPDM gasket resists heat aging and compression set.
- High-torque nylon knobs resist breakage.
- Our patented No-Spill™ Slide Gate is fitted with a magnetic safety latch to prevent accidental closure in high-vibration applications.
- Stainless steel centre drawer guide simplifies removal and re-installation of the magnet drawer for quick, easy cleaning.
- Most powdered colorants and resins slide off without sticking.
- Superior cartridge geometry increases reach-out and holding power.
- Robust construction prolongs cartridge life.

Additional Models to Fit Any Application:

FF350 HIGH-TEMP FF DRAWER MAGNET

Rated to 180° C for high-temp processing

The Bunting® FF350 High-Temp Drawer Magnet answers the growing demand by OEMs and end-user customers to process material at higher temperatures. Higher temperatures improve plastic clarity and performance, particularly in injection moulding. The Bunting FF350 ensures this higher level of product integrity.

We took care to maintain magnetic strength under increased temperatures and incorporated other high-temp features. For example, along with the magnet upgrade, we replaced the standard Lexan viewing window with polycarbonate. Even the plastic knobs are rated for higher temperatures.

The FF350 can be used in any existing plastic moulding or extrusion application. Since the housing for the FF350 matches the profile of the standard model, drawers and other accessories can be purchased separately to upgrade FF Drawer Magnets already in use.



- Equipped with high temperature-compensated rare earth magnets.
- Drawer gasket: Viton sponge material rated to 200° C maximum temperature to resist heat aging and compression set.
- Drawer front constructed from Polysulfone material resists temperatures up to 180° C of intermittent temperature operation.
- High-torque nylon knobs resist breakage at temperatures up to 180° C.
- Rugged, easy-to-clean 11-gauge stainless steel housing built to support symmetrical 10,000 lb compression loads.
- Stainless steel centre drawer guide simplifies removal and re-installation of the magnet drawer for quick, easy cleaning.
- Superior cartridge geometry and construction increases reach-out and holding power while maximizing cartridge life.
- High-temperature parts are completely interchangeable with the standard FF Drawer Magnet.

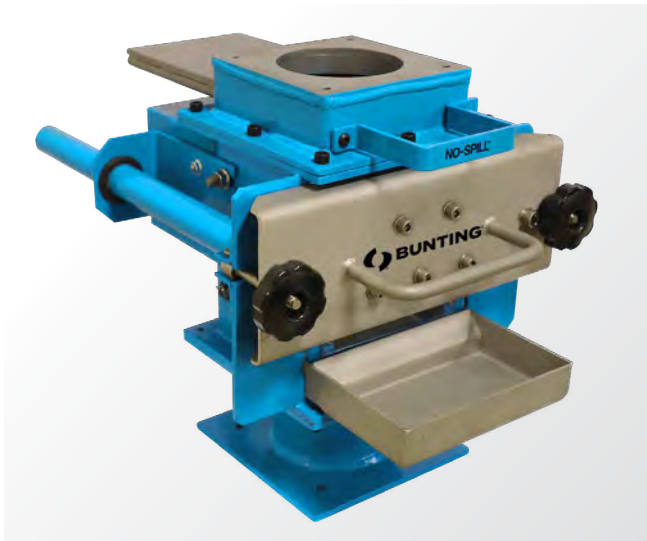

SELF-CLEANING FF DRAWER MAGNETS – MANUAL AND PNEUMATIC

With no need to pull apart components for cleaning, our advanced Bunting® Self-Cleaning Drawer Magnets feature extra-long magnetic cartridges that fit inside stainless steel sleeves. This enables a self-cleaning mechanism as tramp metal collects on the sleeve surfaces, then falls from the sleeves when they are pulled clear of the magnetic cartridges. No wiping or brushing is required. Simply remove the drawer assembly and pull out the magnetic cartridge. With one smooth motion, a separate assembly cleans the magnetic cartridges with grommets. This wipes the metal from the tubes to a tray resulting in less product loss.

- Features rare earth magnets to endure high temperatures without losing magnetisation.
- Customisable design allows drawer to fit most machine openings.
- Welded stainless steel housing for easy cleaning and durability.
- Detachable tramp tray alleviates messy cleanups and spills.
- Pneumatic self-cleaning option also available. Features the additional benefit of control packages for hard-to-reach installations.
- Top slide gate and bottom transition are custom-made to your requirements.

LOW-PROFILE DRAWER MAGNETS

When headroom is severely limited, use Bunting's proven drawer design in a space-saving 150mm overall height. The Bunting Standard Low-Profile Drawer magnet features include a single row of our exclusive NEO magnetic cartridges, clear polycarbonate drawer front, and rigid 10-gauge mild steel construction. Low-profile units are available in stainless steel and with the original No-Spill™ slide gate option. Bunting will pre-drill the unit's rugged 6mm thick flanges to customer specifications at no charge.

- Clear polycarbonate drawer front has leak-resistant seals permitting the monitoring of material flow and tramp iron accumulation.
- Single row of high-power NEO magnetic cartridges.
- Rigid 10-gauge mild steel construction for durability.
- Requires less than 150mm of overall height for installation, allowing for a tight fit in difficult spots.



POWDER FF DRAWER MAGNETS FOR FINE-GRAINED RESINS

The Bunting® Powder FF Drawer Magnet is a modification of the Neo FF Series designed to reduce loss when separating metal from fine product. It separates ferrous metal contaminants from fine-grained PVC and other powdery materials while preventing minimal product from escaping.

- Clear polycarbonate drawer front has leak-resistant seals and permits monitoring material flow and tramp iron accumulation.
- Magnet housing has been redesigned to bear the weight of infeed hoppers and other processing components.
- Inside of the housing is ground smooth to facilitate cleaning and prevent powdered colorants and resins from clinging to the interior.
- The slide gate, completely enclosed within the housing, redirects clinging powder back into the product flow.



FFV DRAWER MAGNETS

Bunting FFV Drawer Magnets are designed for implementation in small-volume and closed-loop applications. These "Just-In-Time systems" dry resin at a central point and then convey small amounts to the moulding machine. FFV Drawer Magnets mount on the throat of plastic moulding machines and are equipped with an o-ring seal at the drawer front to prevent air leaks. The powerful magnetic cartridges can easily be pulled out of the housing for cleaning. Top and bottom flanges are built to your requirements.

- Most compact housing measures just 75mm x 75mm and has a maximum inlet diameter of 50mm with a maximum outlet diameter of 50mm. Larger 100mm x 100mm units are also offered, allowing this product to fit a variety of size requirements.
- Manufactured to withstand pressures up to 15 in-hg without leaking.
- Mild and 13-gauge 304 stainless steel housings are available to suit your application needs.
- Units can be ordered with single or double high-energy rare earth magnetic cartridges to suit your application needs.
- Models with two high-energy rare earth magnetic cartridges can handle applications where extremely small fines or weakly magnetic contaminants are encountered.
- 12mm thick, clear polycarbonate drawer front for strength and easy monitoring of the resin flow and tramp metal collection.

DRAWER MAGNET OPTIONS (AVAILABLE FOR ALL FF DRAWERS):

- 1. No-Spill™ Slide Gate:**
Patented design allows for complete shut-off of product flow, reducing spillage.
- 2. Purge Hopper:**
Speeds cleaning of your equipment when changing color or compound without sacrificing magnetic protection.
- 3. Dump Tube:**
Allows operator to completely empty the drawer housing and material hopper of plastic after job is completed.
- 4. Liquid Port:**
Promotes quick addition of color additive into the resin. Port may also be used to hold temperature probe.
- 5. Powder Seal Kit:**
Provides a compression seal around the Slide Gate to prevent leaking of powdery materials.



HF DRAWER MAGNETS

Bunting® HF Series Drawer Magnets are equipped with powerful magnetic cartridges to handle a wide range of separation tasks in mechanical or gravity flow applications. They can be configured with up to 5 cartridge trays, arranged so that the cartridges are staggered to increase contact with the product stream. Material moves in a waterfall flow pattern from one cartridge tray to the next, resulting in exceptionally thorough cleaning.

- Available in utility, food, and sanitary construction grades to suit your safety regulations, with multiple cleaning options and stainless steel housings.
- Bunting supplies custom transitions to match round, square, or rectangular spouting, allowing for a simple, secure fit with your existing equipment.
- Multiple trays provide increased contact with product flow for more complete metal capture.
- HF Drawer Magnets are available with the NUHI™ Neo Ultra High Intensity Cartridge Magnet. Completely redesigned from the ground up to address the processing challenges manufacturers face, the NUHI™ cartridge is nearly 20% stronger and delivers 50% more reach out than our previous cartridge design. The result is more power, a purer product, and improved plant efficiency. Ceramic and rare earth magnets are also available.
- Manual standard, manual self-cleaning, pneumatic self-cleaning, and pneumatic continuous self-cleaning configuration options are available.

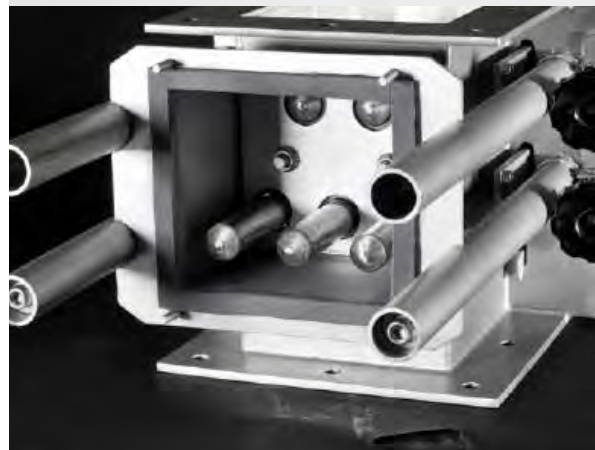

HF DRAWER CONFIGURATION OPTIONS

MANUAL STANDARD

In the manual standard configuration, ferrous debris is removed from the cartridges by sliding the trays out of the housing and wiping them off by hand. This allows for the operator to see exactly how much material was separated out of the product line, giving them insight into the process and providing hands-on interaction.



SELF-CLEANING

The self-cleaning configuration is designed to fully extend the magnetic cartridges outside the housing. As these tube assemblies travel outside the housing, the ferrous metal is wiped from the surface of the cartridge. The collected metal then drops off into a tray outside the housing.



PNEUMATIC SELF-CLEANING

The pneumatic self-cleaning configuration releases ferrous contaminants into the discharge area automatically using pneumatic power. With this model, product flow must be stopped in order to clean cartridges and prevent contaminated products from flowing into product stream. Pneumatic units operate via a toggle control, push button or timer. They can also operate via a Bunting engineered automated control package, making them an ideal choice for installing in hard-to-reach locations.



PNEUMATIC CONTINUOUS SELF-CLEANING

The pneumatic continuous self-cleaning configuration utilizes a special drawer design that allows product to continuously flow while magnets are being cleaned. There is no need for a gate to stop product flow. Each row of magnets is cleaned in an alternating pattern, allowing the product to remain in contact with a row of magnets at all times. This unit operates by remote switch or by a Bunting-engineered automated control package, allowing it to be installed in hard-to-reach locations.



Magnetic Cartridges and Grate Magnets

MAGNETIC CARTRIDGES

Thanks to computer-aided design, Bunting cartridges achieve the optimum balance between magnetic reach-out and holding force. Cartridges can be mounted individually, side-by-side or in multiple-row arrays. Bunting offers ceramic, alnico, neodymium Power-Balanced™ rare earth, neodymium high-intensity rare earth, and neodymium high-intensity rare earth temperature-compensated magnets.

GENERAL-PURPOSE MAGNETIC CARTRIDGES

Both standard and heavy-duty models are constructed of durable 304 stainless steel tubing and are available with threaded hole, threaded rod, or plain sealed end plugs. 316 stainless steel is also available. End plugs are fully welded into the tough 1-inch diameter tubing for added durability.

- Select tapped, sealed or studded ends.
- Standard 1" round cartridges start at 4" lengths.



HEAVY-DUTY MAGNETIC CARTRIDGES

Bunting heavy-duty cartridges are designed for maximum metal removal.

For use where high flow rates or bridging might be a problem, or where structurally stronger cartridges are required. These 40mm square cartridges offer superior reach-out and nearly twice the magnetic surface area of standard 25mm cylindrical cartridges.

- Durable, heavier-gauge stainless steel tubing resists wear and lasts longer in demanding applications.
- High-intensity rare earth magnets are standard.
- Heavy-duty 40mm square cartridges offer nearly two times the magnetic surface area of standard cartridges.

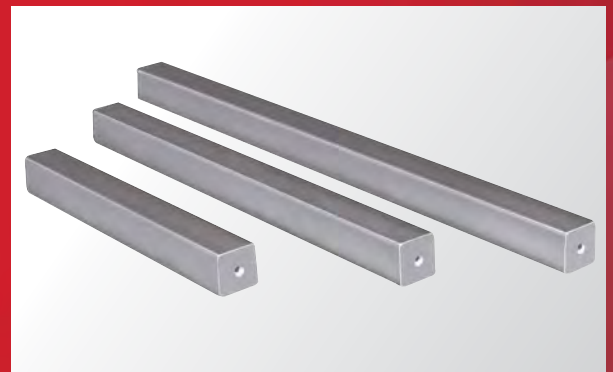

NUHI™ NEO ULTRA HIGH INTENSITY MAGNETIC CARTRIDGES

Completely redesigned from the ground up to address the processing challenges manufacturers face, the NUHI™ cartridge means more power, a purer product, and better plant efficiency.

- Over 105 oz of Pull Strength.
- 316 Stainless Steel Construction to ensure durability.
- 14% stronger than our previous cartridge design.

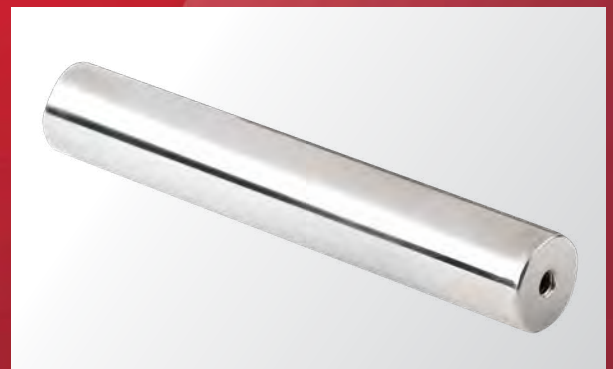

TURBOGRATE™

The Bunting® TurboGrate™ system is designed to remove ferrous metals from powder and granular material with the most difficult flow characteristics.

- Built to fit most gravity flow line sizes, allowing for a seamless fit into your operations.
- Two standard sizes are available for up to 300mm spouting. Can be custom-designed to fit your installation requirements.
- Manual Self-cleaning option available to minimise downtime.
- Equipped with high-intensity rare earth magnets to filter out even the finest of contaminants.

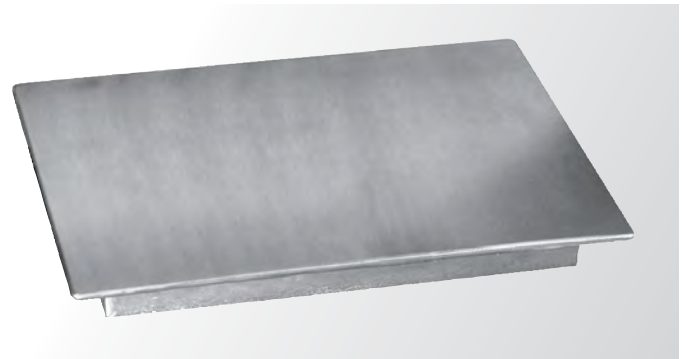

Plate Magnets

Bunting® supplies various types of plate-based magnetic separators that can be implemented into a broad range of applications, and can be used with an equally wide range of materials. All plate magnets are designed for the capture of tramp metal in gravity free-fall applications. Metal-detectable gaskets and grommets are standard features in housing of plate magnets.

STANDARD PLATE MAGNETS

Bunting Standard Plate Magnets are available with permanent ceramic magnets or with high-intensity permanent rare earth magnets. Both types of magnets work efficiently to capture fine metal particles and slightly magnetic debris from powdery, moist, clumpy, or abrasive materials that might choke or wear cartridge-based separators. Plate magnets install easily in chutes to remove ferrous fine particles and larger pieces of tramp iron from many types of free-flowing and pneumatically conveyed material. They can also be installed above conveyors or below conveyor drive pulleys to capture contaminants as material drops from open belts. Standard installation kits include a pre-drilled hinge, latch, and other hardware to ensure easy mounting. The tapered magnetic face is designed to prevent contaminant wipe-off in rapid product flow. Standard plate magnets are available in widths from 4" to 60".



- Ideal for 30° to 60° inclines, allowing contaminants to be trapped as material flows over the plate magnets.
- Food, sanitary, and USDA finishes available to fit your production safety regulations.
- Hinged plates swing out for easy cleaning.
- 300 series SS construction. 316 stainless steel available when required. Tapered step face to prevent product wipe off in rapid product flow is standard with 400 stainless steel.
- Rare earth magnets are available to provide maximum strength and reach out.
- Optional replaceable grain face available for dealing with abrasive materials.

PLATE HOUSING MAGNETS

Bunting® Plate Housing Magnets resist bridging and choking to remove tramp iron and ferrous fine particles from flow-resistant bulk materials. The stainless steel housings mount easily to enclosed spouting or directly on processing equipment. Optional square, rectangular, and round adapters can be supplied or designed to your specifications for ease of installation. A diverter at the top of the housing helps break up clumps and directs product flow over the unit's two powerful plate magnets.

- Excellent for separation of coarse, fluffy, and other flow resistant materials that bridge in grates and drawer magnets.
- A diverter at the top of the housing helps break up clumps and directs product flow over the unit's two powerful plate magnets. Additional removable/replaceable diverters are available.
- Custom transitions for round, square, or rectangular spouting are available to fit any application.
- Economical ceramic and powerful rare earth magnets are both available based on your production needs.
- A self-cleaning option is available for increased efficiency.
- Compact design fits easily into limited spaces, allows for mounting on processing equipment or on spouting.
- Rugged stainless steel construction to resist wear and extend life of equipment.



SUSPENDED PLATE MAGNETS

Bunting suspended plate magnets are designed to be suspended above open conveyors to remove ferrous objects and fines found in grains, feedstuffs, raw and processed food products, dry powders, and other particulates.

- The stainless steel design complies with food and sanitary grade requirements.
- The magnet suspends over a conveyor belt or drop-off point to remove contaminants from dry powders, grains and particulates without interrupting the product flow.
- The powerful ceramic magnet field reaches deep into conveyed material to pull ferrous tramp from flat-belt and trough conveyors. Rare earth magnet models are available for applications that require greater magnetic power.
- Sturdy, free-standing, bolt-together support frames enable convenient mounting.
- Optional stripper plate slides out for fast, easy, out-of-the-way cleaning.



Our Suspended Plates come in sizes matched to common belt widths and are outfitted with eye-bolts to aid in handling and overhead suspension.

- 950 Suspended Plates are designed for deep 10" reachout troughing applications and for high conveyor speeds of 100 to 300 fpm.
- 650 Suspended Plates are designed for medium-duty and lighter burden depth where 6 1/2" reachout is adequate. The 650 Series is a cost effective choice when dealing with lighter product density, lower conveyor speeds, or thinner burden depths.
- 450 Suspended Plates are designed for light-duty flat belt applications with a 4 1/2" reachout. They can be upgraded from ceramic to rare earth magnets, resulting in higher intensity magnetic fields to separate metal fines from thin, light layers of products conveyed at speeds under 100 fpm on flat belts.

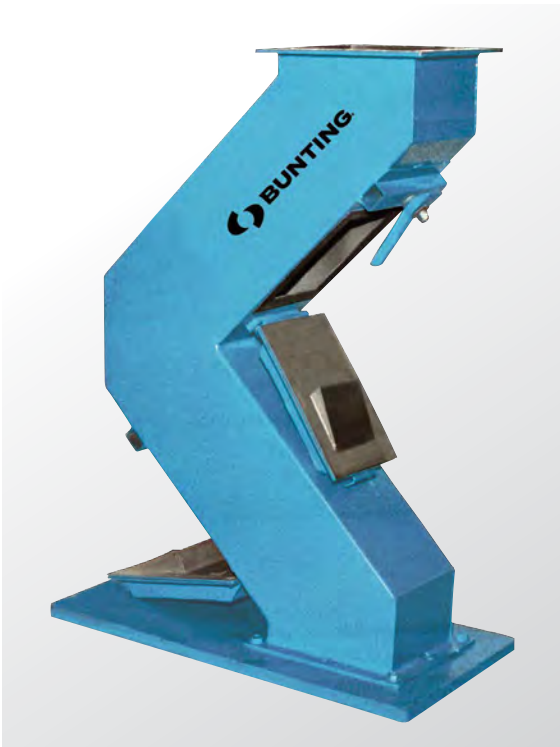

HUMP MAGNETS

Hump magnet separators are specifically built to handle high-volume product flow. Available in hump and half-hump housings, they are designed for installation in enclosed flow lines or on processing equipment.

STANDARD HUMP MAGNETS

Hump magnet housings handle gravity, moderate positive, and negative pressures. Their angled shape directs the product flow into the magnetic field, helps prevent build-up and bridging, and assists in breaking up clumps of product for increased protection against entrapped ferrous debris.

Offset design breaks up clumps and directs material into magnetic field.

- Select double or single hump housings sized and outfitted to your specs.
- Available with mild steel or stainless steel construction. Custom transitions for round, square, or rectangular spouting are available to fit any application.
- Hinged plate magnets swing open for quick manual cleaning.
- Self-cleaning models reduce cleaning time and labor.

HALF HUMP MAGNETS

Half-hump magnets are used where standard hump magnets will not fit because of height restrictions. Like its larger version, the half-hump housing directs the material flow over the single high-strength permanent magnet, and breaks up aggregated material to dislodge and capture embedded metal contaminants.

WEDGE MAGNETS

Bunting® Wedge Magnets are designed to provide efficient, economical protection against the damage that can be caused by tramp metal contamination. They are an excellent choice for implementation in pellet mills, or with other equipment used in processing particulate or semi-solid materials. Wedge magnets efficiently process materials moving under gravity flow.

- Design allows for easy installation in difficult areas, such as narrow chutes.
- Wedge magnets require minimal mounting space, allowing for extra ease in installation.
- Stainless steel construction resists wear and corrosion.
- Unique wedge shape helps prevent product build-up and bridging, keeping material moving smoothly through the production line.
- Available in both ceramic and rare earth magnet configurations.



- Direct drive is standard with an optional variable speed control based on your application needs.
- Open-style design (free of housing) is ideal for installing at the end of conveying machines, (such as chutes), for removal of ferrous contaminants.
- Totally enclosed design (equipped with housing) is ideal for applications where product must be kept free from external contamination. It also protects your employees from inhaling any dust being given off from the product.



DRUM MAGNETS

Bunting manufactures many types of drum separators, ranging from heavy-duty electro drums for separating ferrous metals from non-ferrous metals, to permanent magnetic drums for fine iron separation. The magnetic drum separator is normally installed at product discharge points and incorporates a 65° – 82° C magnet system, encased in a stainless steel shell, or manganese wear plates for severe application. This system pulls iron contamination out and behind the clean product path and discharges it automatically while the clean product continues its normal trajectory. Bunting Drum Magnets are self-cleaning and provide continuous separation of ferrous contaminants from a wide range of free-flowing bulk and granular materials in high-volume applications.

STANDARD DRUM MAGNETS

- All drum magnets are available in electromagnetic or permanent designs, as well as including the option to be made with a high intensity rare earth magnetic system (ideal for separation of exceptionally small contaminant particles).
- Allow continuous separation and cleaning without interruption to the product flow.
- Ideal for high-flow, heavy-contamination applications.
- Stainless steel drum, mild-steel, or stainless steel housings to suit your application needs.
- Bunting supplies custom transitions to match round, square, or rectangular spouting, allowing for a simple, secure fit with your existing equipment.

In-Line Magnetic Separation

PNEUMATIC IN-LINE MAGNETS (PIM)

Pneumatic in-line magnets are built for use in dilute phase pneumatic conveying systems. They can be installed easily with optional factory-supplied compression couplings and, work best in horizontal runs with the plate magnet down to take advantage of material stratification. Pneumatic in-line magnets feature full-flow architecture to allow an unobstructed product stream.

- Designed for unobstructed product flow in dilute phase conveying up to 15 psi.
- Best suited for horizontal installation, but can work in vertical installations.
- Portable carts are available.
- Compression couplings speed in-line installation.
- High-energy rare earth tapered step plate magnets are standard.
- Tapered transitions guide material directly over the face of the hinged plate magnet, which swings away from the housing for quick external cleaning.
- Food, sanitary, and USDA finishes available to fit your production safety regulations.



CENTRE-FLOW IN-LINE MAGNETS (CFM)

Centre-flow in-line magnetic separators are engineered to remove ferrous fine particles and larger pieces of tramp iron from dry particulates as they travel through dilute-phase pneumatic conveying lines. To achieve optimum contact with the product flow, a conical magnet is suspended in the centre-line of the housing. This tapered, exposed-pole cartridge has a stainless steel “nose cone” to direct the flow of materials around the magnet. The magnet’s tapered poles allow ferrous fine particles to collect out of the direct air stream. Additionally, the trailing end of the magnet is an active pole which will collect any tramp metal that gets swept down the cartridge.

- Designed for unobstructed product flow in dilute phase conveying up to 15 psi.
- Available with all line and fitting types. Placement in vertical run makes optimum use of the magnetic field and ensures maximum efficiency in separation.
- High-energy rare earth magnets are standard.
- Optional clear view inspection port to observe separation process.
- Comes standard with a tapered step face to prevent product wipe off.
- 80 and 100mm models are manufactured using new bolt-on flange design for quick delivery.

GRAVITY IN-LINE MAGNETS (GIM)

Bunting® Gravity In-Line Magnets allow you to utilise our powerful plate magnets in round, sloping spouting where material is under gravity flow. For effective tramp capture, spouting should be angled no more than 60° from horizontal.

- Tapered step magnet. Effective for capturing material under gravity flow in round, sloping spouting.
- Food, sanitary, and USDA finishes available to fit your production safety regulations.
- Built to fit most gravity flow line sizes, allowing for a seamless fit into your operations.



Cutaway section to show magnet..



TORPEDO IN-LINE MAGNET (TIM)

Bunting® Torpedo In-Line Magnets (TIM) provide high strength permanent Neodymium Rare Earth magnetic protection for vacuum systems. Torpedo In-Line Magnets clamp directly into flexible hoses to capture ferrous tramp metal from bins, hoppers, and gaylords. The unwanted metal is pulled from the product line without the material flow being impeded.

Torpedo In-Line Magnets feature:

- Space-saving design making them a perfect choice where overhead space is limited.
- Available in three sizes to suit tubing.
- Cleaning is fast and easy. Simply disconnect the quick-release tri-clamp fitting to separate one half from the other and wipe the tramp metal down the cartridge and off the end. The precision designed housing is designed for leak-free operation, easy cleaning, and frequent inspection.

Magnetic Pull Test Kits

FIELD TESTING YOUR MAGNETIC SEPARATION EQUIPMENT

Bunting offers two options of magnetic pull test kits designed to field test your magnetic separation equipment.

MAGNETIC PULL TEST KIT WITH STANDARD SCALE

Measure the force of your magnetic separation equipment with this affordable, reliable Bunting Pull Test Kit with Standard Scale. The test pieces and tools have been selected for testing a broad range of separation equipment and configurations. This precision instrument ensures consistency and repeatability, which are critical to gathering reliable test data from monitoring magnetic strength over time.

The standard-scale kit includes:

- 0 to 1/2-lb x 8-oz. force gauge
- 1 lb calibration weight
- Multi-gap spacer block
- 1/4" test ball
- 1/2" test ball
- 1/8" x 1" x 3" plate test piece
- Polarity indicator
- Storage case

IMPROVED MAGNETIC PULL TEST KIT WITH NIST-TRACEABLE DIGITAL SCALE

Regular pull tests are critical for any magnetic separator, but especially for those used by food and pharmaceutical handlers due to the risk of contamination at any stage. The precision performance and calibration options of the Bunting custom-made digital scale make it superior to spring scale kits. Easy to use and competitively priced, the Bunting Pull Test Kit with Digital Scale includes an improved polarity indicator and a magnetic field-strength indicator for optimising spacing between cartridges.

An optional version of the digital scale comes with National Institute of Standards and Technology (NIST) calibration check certificate, which is compliant with ISO and other quality and safety programs and renewable with the annual checkup and calibration.

The digital kit includes:

- Digital scale (NIST-optional traceable calibration)
- Digital scale charger
- Spacer block
- Test plate
- 1 lb calibration weight
- 1/4" test ball
- 1/2" test ball
- Polarity indicator
- Storage case



METAL DETECTION

Even the smallest amount of metal contamination in plastic products can seriously harm a customer, devastate a brand's reputation, and inflict the heavy financial costs of liability, product recall and damage to production equipment.

Metal particles are the most common source of foreign contamination in plastics processing. This contamination frequently enters the product stream as a result of the wear and breakage of other processing equipment in the production facility.

Bunting metal detectors are able to sense and reject extremely small ferrous metal particles from the process flow or from shredded recycled material, even detecting metal encapsulated in individual plastic particles.

With Bunting® metal detection equipment integrated into your process, you will be able to send your product to market with complete confidence.

HOW METAL DETECTORS WORK

The product passes through an opening in the detector, which houses a unique three-coil search head. This is comprised of windings around an aperture opening, whether round or rectangular. There is a transmitter in the centre of this coil with two receivers surrounding it, one placed at the entrance of the search head and one at the exit. Within the aperture opening, an electromagnetic field is created. When a piece of metal passes through the coil opening, a signal is generated and calculated at each and activates further operations or devices. All metal detectors utilise electronic control packages designed by Bunting to specifically fit with our metal detection equipment.

Some metal detectors are equipped with automatic reject mechanisms, which isolate contaminated material and remove it from the product flow. Bunting's automatic reject mechanisms operate quickly and efficiently, meaning that the removal of contaminated product does not come at the expense of slowing down your greater operating process.

BUNTING DESIGN ENSURES MECHANICAL INTEGRITY

As our description of metal detector operation suggests, metal detectors are highly sensitive, precisely calibrated instruments that can be affected by vibration, electrical fields, and other environmental conditions.

To ensure the most reliable operation in demanding environments, Bunting metal detectors are designed and manufactured to a higher standard of durability and signal strength. The search head is filled with catalysed epoxy, allowing no void areas inside the housing. This waterproofs the search head and stabilises it against vibration. Coils and electronics may be rated for dust and water protection from IP54, to IP65 and IP69k.

BUNTING QUALITY CONTROL

Depending on the level of electronics you select, Bunting® metal detectors have recording and reporting functions within the software. Optional features allow your organisation to connect detectors for remote monitoring, reporting or control.

SELECTING THE BUNTING METAL DETECTOR FOR YOUR OPERATION

Plastics companies must manage unique process flow conditions and the challenges of handling many different types of material. To assist our customers in choosing the metal detector best suited for their operating conditions, we pair each customer with a Bunting representative to aid their decision making process. Your Bunting representative is available to consult at any phase of the design process, and can assist in both integrating new equipment into established operations as well as planning a new facility from scratch.

Your Bunting representative consults at any phase of design, whether integrating into mature operations or planning a new facility.

Your part in the system integration is greatly simplified by our extensive portfolio of products, options, and by our more than 60 years of manufacturing and customer service innovation.



Electronics for Metal Detection Equipment

AVAILABLE ELECTRONICS

Bunting offers the most advanced metal detector controls in the industry, delivering superior results while still maintaining a user-friendly, easy to understand operating system. Our metal detectors for the plastics industry are equipped with 1 of 2 different electronics control packages. The metal detector controls are specific to the system type and application needs. All metal detector equipment requires an electronics package in order to operate.

07 ELECTRONICS

- Easy-to-use color touch screen.
- 3 levels of user access for added security.
- USB interface for simple data exchange of backup, updates and quality control logs.
- Compliant with quality surveillance rules according to HACCP, IFS, BRC and SQF.
- Automatic product learning, stores up to 500 unique products.
- imagePHASE™ revolutionary product imaging software delivers improved sensitivity and superior learning in difficult product applications.
- Triple frequency allows the operator to process a wider range of items through the detector with ease.
- Variety of configurations available due to network-enabled system components, including remote monitoring and control via ethernet, wifi, or integration into other processing equipment.



05 ELECTRONICS

- Four button text pad controls with simple menus provides quick access to operating parameters.
- Automatic product learning. Stores up to 500 unique products using an SD card.
- SD card interface for simple data exchange of back-up, updates, and quality control logs.
- Built-in product-effect compensation eliminates false rejects.
- Noise suppression eliminates the effects of electronic interference.
- Self-monitoring system warns if any components are not functioning properly.



03 ELECTRONICS

- Compact, easy-to-use controls.
- User-selected sensitivities and reject parameters.
- Built-in product-effect compensation eliminates false rejects.
- Self-monitoring system warns if any components are not functioning properly.



Metal Detectors for Plastics Processing and Recycling

Gravity Free-Fall Style Metal Detectors with Reject Mechanism



quickTRON™ 03R

This low-cost, triple-coil detector offers superior sensitivity, simplicity, and reliability. The Bunting® quickTRON™ 03R is specifically designed for demanding applications in the plastics and recycling industries.

- Consistently detects and rejects small fine materials that other metal detectors struggle to detect.
- Handles detection and removal of fine metal contamination in critical processes.
- Housing controls are contained to eliminate risk of interference.
- High-speed stainless steel reject mechanics allow for economical, compact design.
- Units are fully self-monitoring.
- Integral brackets simplify mounting.

quickTRON™ 05 (FLAP OR COWBELL STYLE DIVERTERS)

The Bunting quickTRON™ 05 uses a CR coil for reliable metal detection and is a cost-effective option for the examination of bulk material in gravity free-fall applications.

- Flap option is recommended for powders, fine granular, or dry products.
- Cowbell option is recommended for abrasive, sticky or non-powdered products.
- Equipped with simple 05 controls. Remote mounted controls available.
- Stainless steel, washdown, or painted versions available to suit your operating needs.
- ATEX explosion proof rating available. Hazardous environment rating available for flap style unit.
- Able to accurately detect contamination even within abrasive products.





HS 9050/9100

Entry-level, economical Bunting® HS metal detection systems pneumatically reject isolated metal debris from powders, granules, and other bulk materials used in gravity-fed plastics and recycling applications.

- Economical, compact, and versatile.
- Adjustable sensitivity and rejection. Air-powered stainless steel flap offers rapid rejection cycling for cleaner results.
- Low-maintenance operation. HS detectors self-monitor their sensors, mechanical function, voltage, and air pressure.

MACHINE MOUNTED ALL-METAL SEPARATORS (MMS)

The Machin Mounted All Metal Separator provides efficient detection and rejection of both ferrous and nonferrous metal contaminants within all materials, whether loose or encapsulated, without process interruptions. The MMS is designed for mounting on an injection moulding machine or extruder as a “last chance” metal detector. This type of detector, also available in a high-temperature rated model uses a pneumatic rejection mechanism to remove metal contaminants that were detected previously in the process flow.

- Designed especially for choke-feed applications, the MMS can bolt directly to the infeed of processing equipment and support the weight of hoppers and bins.
- Fast pneumatic rejection mechanism, (aided by precise timing), results in accurate cycling and conservation of good material.
- Slide gate rejection design eliminates contamination leaks.
- Available in a high-temperature version suitable for handling product at higher-than-normal temperatures (up to 180° C).



Web Detection Metal Detector

The profiLINE™ is a flat coil metal detector for Film or Web industry and helps ensure quality in films and non-woven textiles. The metal detector can protect calendar rollers and removal of needles in film. Also can ensure metal-free food-grade plastic film.

profiLINE™ 04/05

These flat coil detectors prevent costly repairs and production downtime. Units are self-monitoring for added reliability. The profiLINE™ features advanced circuitry which reduces false signals and product waste.

- Extremely low profile with superior sensitivity on coil surfaces.
- 12 inch wide segments for pinpoint accuracy.
- Available up to 40 feet wide.
- Individual LED Outputs.
- 04 Software enables you to pinpoint contaminated zones. Multi-port output to trigger other processing equipment.
- 04 is a multi-segmented metal detector for the inspection of webs . (woven, nonwovens and inspection of plastics film)

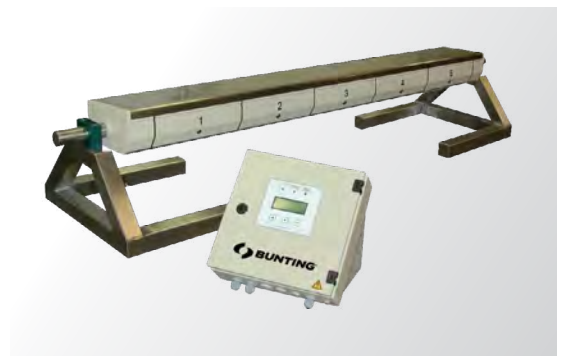

profiLINE™ 05

- Extremely low profile with superior sensitivity on coil surfaces.
- Available up to 40 feet wide.
- 05 Software delivers a single overall control zone.
- 05 is an Electronic single sided metal detector for the inspection of webs. (woven and nonwovens)



Pneumatic Conveying Metal Detectors with Reject Mechanism

Pneumatic style metal detectors detect and reject ferrous and non-ferrous metals in enclosed pipe systems. They are ideal for implementation in pressure, suction, or vacuum conveyor lines. All systems are easy to operate, maintenance free and quick-acting.

pTRON™ 03

This pneumatic style metal separator is ideal for intermittent vacuum conveying lines. The pTRON™ 03 has a quick-acting rejection point supported by a powerful, durable, maintenance-free pneumatic actuator. It provides efficient detection and rejection of both ferrous and nonferrous metal contaminants within all materials, whether loose or encapsulated, without process interruptions.

- Extremely flexible construction allows for both horizontal and vertical installation into existing systems.
- Operating procedures are user-friendly and prioritise safety.
- Equipped with the newest detector coil technology available, making it highly precise, highly reliable, and immune to external disturbances.
- LCR Compact with an interference shield.
- Quick-acting reject flap for minimal loss of good product
- Minimal loss of good product no loss of vacuum during reject event.
- Conveying speeds up to 30 m/sec.
- Features 03 electronics controls.
- Option for abrasive products.

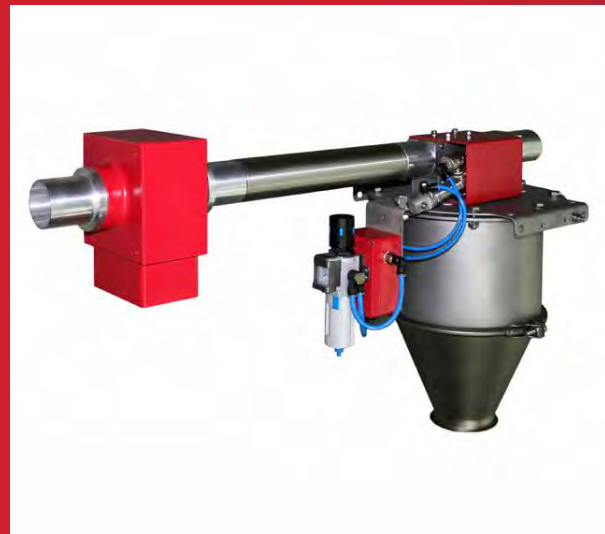

pTRON™ 05 & 07

Provides efficient detection and rejection of both ferrous and nonferrous metal contaminants within dry granular or powder material traveling through a vacuum or pressure conveyance system.

- Fast acting flap reject assures minimal loss of good product while ensuring reliable separation of contamination.
- Positive speed control assures that the flap activates at the precise time required.
- Double pinch-valve reject assures no loss of system pressure.
- Features 05 or 07 controls.
- ATEX hazardous environment rating available.
- Self-monitoring
- Product compensation

Metal Detectors for Conveyors

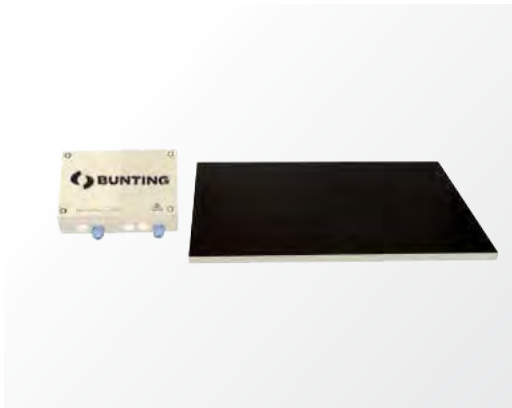

meTRON™ 03 SL

Installed directly under conveyor belts, triple-coil Bunting® meTRON™ SL detectors monitor flat products and materials with shallow burden depths.

This low-profile detector features:

- Easy to install without excessive modifications.
- Slider plate is not required.
- No metal free zone required.

meTRON™ 05 VT

Designed to fit into vibration conveyors with little modification.

- Quick and easy installation.
- Models to fit every application.
- No metal free zone required.



meTRON™ 05 D

The Bunting meTron™ 05 D is a two-piece, tunnel-style metal detector that can be separated in order to install around belt conveyors. It offers triple-coil sensitivity and accuracy, is easy to install, and provides stable performance. This two-piece, tunnel-style detector is perfect for belt conveyors and vibratory chutes.

- Automatic product tracing and temperature compensation.
- Easy installation and user-friendly operation.
- Triple-coil sensitivity and superior accuracy in detection.
- Overall waterproof construction, in addition to an epoxy-filled search head allows for maximum protection of internal components.
- Serial interface (RS-232) with multi-level password protection and a built-in digital event counter.
- Combination assemblies with detector and conveyor can be custom-built to suit your application utilising a variety of rejection devices, including pusher, flap, or cut-out styles.

meTRON™ 05 S

These single-sided, triple-coil under the belt detectors install in belt conveyor systems and scan through the belt into product with a maximum burden depth of six inches. This single surface detector works well for Belt Conveyors and Vibratory Chutes.

- Features Triple-coil circuitry for accuracy
- Equipped with EMFI filters for reduced waste, misses, and false alarms
- Features low-profile construction and superior reach-out
- Uses 05 Controls

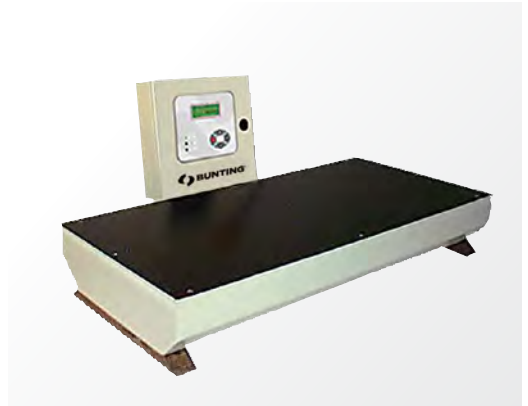

TUNNEL STYLE METAL DETECTORS

Bunting® tunnel style metal detectors feature epoxy-filled search heads that are waterproof and isolate sensitive internal components from outside damage or interference. Tunnel style metal detectors are capable of detecting ferrous and non-ferrous metal contaminants from plastic packaging.



meTRON™ 05 & 07 CI

The Bunting meTRON™ features a tunnel style feedthrough system, closed loop, and integrated controls (CI) for use in conveyors, chutes, and troughs.

- Operates perfectly in wet spaces. Persistent assault from high-pressure cleaning and aggressive cleansing agents will not damage the durable stainless steel search heads.
- Epoxy filled search head is waterproof and isolates the coils from vibration.
- Proprietary Bunting construction design creates the smallest metal-free zone possible and shields the search head from outside interference.
- Constructed in Epoxy Painted IP54 (05 Controls) or Stainless Steel IP66 or IP69K (05 or 07 Controls).
- Custom aperture sizes are available to ensure the perfect fit in your application.
- Available with remote-mounted controls.
- ATEX explosion proof rating available.
- Also available with our 05 control package.

meTRON™ 07 CI

Now Available with Optional Triple Frequency Controls

New integrated controls enhance our innovative imagePHASE platform by allowing the processor to learn a packaged food product in three different conditions, and select the one with that yields the greatest sensitivity. With the upgrade to these controls, the detector also displays the expected sensitivities to the operator with all three metal types: ferrous, non-ferrous, and stainless steel.



meTRON™ 07 CI with CONVEYOR

Bunting® has developed the meTRON™ 07 CI to incorporate a custom designed conveyor belt system to allow accurate metal detection while maintaining quick, efficient product flow. All units are custom-built to exact specifications and arrive ready for installation.

The following items for the metal detection conveyor can be customised:

- Available in stainless steel for wash-down environments or painted steel for non-wash-down environments.
- Available in detector conveyor belt (DCB) or detector conveyor modular belt (DCM) with modular or fabric belting options.
- Direct drive reducers and motors.
- Optional controls with start/stop buttons or variable speed with encoder.
- Adjustable height leveling pads or casters.
- Variety of reject options, including belt stop, belt stop and reverse, air blast, 90° pneumatic pusher, 45° sweeper arm, retracting nose pulley, decline nose pulley, or flap gate on end of conveyor.
- Designed to match your production speed with fixed or variable speed drives. From .72 to 100 fps.
- NEMA 4X rating available for wash-down environments.
- ATEX explosion proof rating available.

* For non-wash-down applications, alternative versions are available.



Cleaning Systems

Many companies find it effective to combine multiple Bunting® products in order to create what is called a "cleaning system". A Bunting cleaning system utilises magnetic separators and metal detectors assembled together in multiple combinations in order to ensure maximum protection against ferrous and nonferrous debris. They are the perfect solution for purifying regrind and recycled goods in a plastics plant.

Cleaning systems combine magnetic and electronic separators to remove both ferrous and nonferrous contaminants efficiently from free-flowing virgin resins, regrind, and recycled plastics. They are an excellent choice wherever the volume and variety of metal debris might overload a single separator. The sturdy steel framework provides easy component access and includes a receiving hopper.

DUPLEX SEPARATOR

FF Drawer Magnet and Electronic HS Metal Detector

By capturing ferrous debris, the drawer magnet reduces the number of HS reject cycles, which further reduces material waste. The HS detector acts as a backup for removing ferrous contaminants and rejects other common nonferrous metal contaminants as well. Working in tandem, these two component separators can eliminate virtually all tramp metal from a plastics process.



BY THE PRESS CLEANING STATION

FF Drawer, Manual Self-Cleaning and quickTRON™ 03R

The FF Drawer will capture any ferrous fines while the electronic metal detector senses and rejects both ferrous and nonferrous metals. It offers adjustable sensitivity and a fast-acting rejection mechanism.

GAYLORD CLEANING STATION

Protection Against Ferrous And Non-Ferrous fines.

The FF Drawer will capture any ferrous fines while the electronic metal detector senses and rejects both ferrous and nonferrous metals. It offers adjustable sensitivity and a fast-acting rejection mechanism.



Metal Detection Service

PRO-START™

Bunting PRO-START™ commissioning coverage ensures that your metal detector performs to your expectations from its first day on the job.

A factory-trained Bunting service technician will arrive at your site to help verify your installation, calibrate your metal detector to peak performance, and train your personnel. You will receive a calibration label for your metal detector, a highly detailed calibration record for your files, and a complimentary set of test spheres or sticks.

PRO-START also extends the original one-year factory warranty to two years total, including technical support. This makes PRO-START an unbeatable value and a must-have package for new installations.



PRO-MAINTENANCE™

The Bunting PRO-MAINTENANCE™ plan helps keep your metal detector operating like new every minute of its service life. It provides you customer satisfaction and protects your product integrity and brand reputation.

Under the PRO-MAINTENANCE™ plan, factory-trained service technicians visit your site once a year (Gold Plan) or twice a year (Platinum Plan) to service and calibrate your metal detector, as well as ensuring your software is fully up to date.

The PRO-MAINTENANCE™ plan includes significant parts-and-labor discounts, on-site training for your personnel, two years of technical phone support, and a complimentary set of test spheres or sticks.

The cost of PRO-MAINTENANCE™ is a small price for peace of mind and peak, uninterrupted operation.

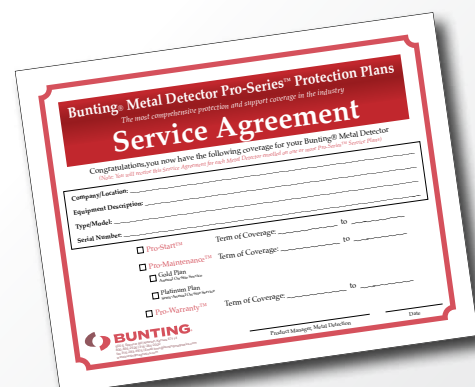

Metal Detector Warranty Solutions

PRO-WARRANTY™

The Bunting PRO-WARRANTY™ plan extends your factory-authorized warranty coverage for up to full five years from the install date. This cost-effective coverage includes all repair parts as well as labor costs when an on-site visit is required. The extended PRO-WARRANTY is available only on new Bunting metal detectors in one-year increments beyond the initial one-year warranty, for a maximum of five total years of coverage.

The PRO-WARRANTY plan also includes free software updates, expedited spare parts, and additional discounts applied to any new metal detection equipment purchased during the warranty period. Free technical support by phone for the whole warranty period is also available.

Avoiding board replacement expense alone justifies the cost of your warranty purchase. One year of our Pro-Warranty coverage is about half the cost of one replacement board. PRO-WARRANTY™ provides the confidence that only a factory-authorized plan can.

Purchase of a PRO-WARRANTY plan requires that the customer made a PRO-START™ service purchase at the time of the original equipment purchase.



METAL DETECTOR TEST STANDARDS

Easily and economically maintain consistent operation and product quality with Bunting certified test balls, wands, and sticks for metal detector calibration and performance checks. These test standards are laboratory-certified and available in ferrous, non-ferrous, and stainless steel in a variety of sizes.



REQUEST MORE INFORMATION ABOUT OUR PRO-SERIES™ PROTECTION PLANS
e-mail: bmc@buntingmagnetics.com, or call: 800-835-2526

CONVEYORS AND CONVEYOR SYSTEM

For conveyors used to move material, feed shredders and remove contaminants from recycled plastics. Bunting® innovative conveyors will enable you to run your operation more smoothly and safely at every point in your process. Many companies are regrinding their scrap and purgings in-house. Bunting provides a complete line of Shredder/Grinder Feeder Conveyors with and without Metal Detectors to protect your equipment and purify your product.



PARTS HANDLING MOVE-IT™ CONVEYORS

Bunting® MOVE-IT Conveyors are available in stock sizes, meant to fit common conveyor dimensions, and can also be custom-designed to fit your unique conveying needs at no additional charge. These conveyors can be custom-ordered in a wide range of lengths and widths to fit your application.

- All models feature sturdy construction, heavy-duty bearings and a simple, straightforward design that is reliable and easy to maintain.
- Electrical components and variable-speed drive motors are available to match the power needs of each installation.
- Durable cleated belts allow you to move parts and scrap up and down inclines, as well as along horizontal runs for maximum layout flexibility.
- Belt styles include standard fabric belts, cleated belts for steep inclines, and scoop cleated belting for ultimate versatility.
- Several conveyor styles are available to best suit your application needs and integrate with your existing equipment.
- Belt angle adjustment allows operators to set incline over a wide range.
- Formed steel frames are shaped and braced for exceptional rigidity.
- Strong, heavy-duty locking casters allow for portability.
- Elevator models have a built-in chute that collects parts or scrap for transport, and cleated belts for even product flow.
- Adjustable discharge chute for conveying small parts in bulk.
- Fixed-speed DC, variable-speed AC, and robotic-controlled gear motors are available.

MOVE-IT STYLE A – STRAIGHT FRAME

- Ideal for horizontal or incline conveying to grinders, totes, or onward to the next work station.
- Also serve under-press applications, box transfer, and scrap removal.
- Optional built-in chute collects parts or scrap for transport.
- Standard belts can be used for 10° inclines. For higher angles, cleated belts keep materials moving.



MOVE-IT STYLE B – HOCKEYSTICK

- Ideal for receiving parts that are discharged underneath machinery in order to convey them to totes or onward to other conveyors. Available inclines are 300, 450, and 600.
- Standard belts are durable PVC with 1.5-inch cleats and polypropylene belts with 2-inch cleats, both on 16-inch centres, allowing for exceptional holding of materials being conveyed.
- Standard infeed flaps contain product and prevent spillage.



Other Move-It Conveyor Styles

MOVE-IT STYLE C – Z-SHAPE

- Combines the capabilities of horizontal and incline conveyors in a single unit.
- Best for collecting parts from underneath machinery and conveying them to totes or other conveyors. Available inclines are 30°, 45°, and 60°.
- Standard fabric belt is durable PVC with 38mm high cleats on 400mm centres, allowing for exceptional holding of materials being conveyed.
- Standard infeed flaps contain product and prevent spillage.
- Optional Mattop belt.

MOVE-IT STYLE D – NOSEOVER

- Receives parts from an overhead robot and lowers them to an operator or a tote. Can also be used to elevate parts to totes or grinders.
- Can include high-friction or cleated belts, depending on the part and the incline. Standard incline angles are 30°, 45°, and 60°.

MOVE-IT STYLE E – ELEVATOR

- Receives small parts from overhead operations and conveys them to consolidation areas.
- Standard fabric belt is durable PVC with 25mm cleats on 150mm centres. Higher cleats are recommended for steep inclines to ensure the most efficient holding of material. Available inclines of 45°, 60° and 75°.
- Comes equipped with standard infeed hoppers and discharge chutes.



Grinder/Shredder Feed Conveyors

Combine Grinder/Shredder Feed Conveyors with Optional Metal Detectors for Protection from Ferrous and Nonferrous Tramp

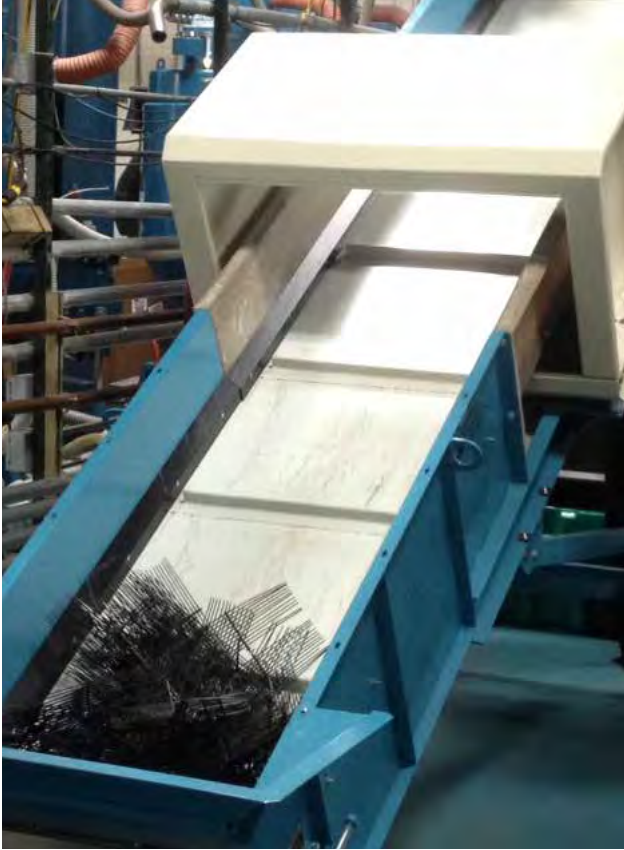

Bunting grinder/shredder feed conveyors easily implement into your existing facility for efficient, economical conveying of material.

These conveyors can be matched with metal detectors to provide additional protection against damage for your machines against ferrous and nonferrous metal. A dual-function metal detection unit can also monitor plastic parts.

Combine an option-rich Bunting conveyor with one of three optional metal detectors that sense all conductive materials, and feature self-diagnostics for easy adjustment and reliable operation. All three metal detector options use a triple-coil, high-frequency metal detection system with product-effect compensation and EMI/RFI filter.



Feeder Conveyors for Shredders and Grinders



LIGHT-DUTY GFC HOCKEY STICK CONVEYORS

- For in-house use next to machine grinders, ideal for handling hand-fed low-volume applications.
- Constructed of a durable fabricated steel frame, features smaller drives and 3" to 6" pulleys with cleated or ruff-topped belts.
- Available with an over the belt plate magnet or an under the belt meTRON™ S 05 metal detector.

STANDARD-DUTY GFC CONVEYORS

- Used in systems that are shredding and grinding materials such as plastic purgings and plastic bottles.
- Handles between 1,000 to 10,000 pounds of material per hour.
- Durable formed steel frame construction.
- 6" to 10" pulleys are available, with options for custom design.
- Multiple belt options available, offering standard cleats or cleat topped belts.
- UHMW, formed metal or rubber skirting.
- Optional metal detectors with available flip gate reject mechanism.
- Optional accessories available, such as in-feed hoppers, magnetic pulleys and mobile bases.



HEAVY-DUTY GFC CONVEYORS

- Used in systems that are shredding and grinding materials such as plastic purgings and plastic bottles.
- Handles between 5,000 to 20,000 pounds of material per hour.
- Durable formed steel channel frame construction.
- 10" to 12" pulleys are available, with options for custom design.
- Multiple belt options available, offering beefy cleats or cleat topped belts.
- UHMW, formed metal or rubber skirting.
- Optional metal detectors with available flip gate reject mechanism.
- Optional accessories available, such as infeed hoppers, magnetic pulleys and mobile bases.

SHREDDER/GRINDER FEEDER CONVEYOR OPTIONAL ACCESSORIES

- Small or large in-feed hoppers
- Single or dual sided sorting table conveyors
- Work mezzanines
- Bale break stations

Shredder Discharge Conveyors



LIGHT-DUTY GRINDER FEEDER CONVEYOR HOCKEY STICK CONVEYORS

- Designed for flow rates under 1,000 lb/h.
- Constructed of a durable fabricated steel frame.
- Smaller drives with 3" to 6" diameter pulleys.
- Inexpensive smooth, ruff-topped or cleated belts.
- Optional under the belt meTRON™ S 05 metal detector.

STANDARD-DUTY GRINDER FEEDER CONVEYOR HOCKEY STICK CONVEYORS

- Designed for flow rates of 2,000 to 10,000 lb/h.
- Rugged formed steel frame construction.
- Uses 6" to 10" diameter pulleys with optional magnetic pulley.
- Heavy cleated cross-rigid flex wall belts.
- Flared in-feed hoppers to match shredder discharge opening.
- Optional under belt metal detectors, including optional flip gate reject mechanisms.
- Can be used as direct transfer of material from shredder to grinder. Mobile bases available to facilitate easy transport of equipment.



HEAVY-DUTY GRINDER FEEDER CONVEYOR HOCKEY STICK CONVEYORS

- Designed for flow rate of 8,000 to 20,000 lbs of product per hour.
- Constructed of formed steel or channel iron frames that are built to withstand the toughest operating conditions.
- Heavy cross-rigid cleated or cleat top belt options available.
- UHMW skirting or formed metal options available.
- Flared in-feed hoppers to match up to shredder discharge openings.
- Uses 10" to 12" pulleys with large drives.
- Optional accessories include: magnetic crossbelt separator, magnetic head pulley, or meTRON™ D 05 metal detector with flip gate rejects for contaminant.



SHREDDER/GRINDER DISCHARGE CONVEYOR OPTIONAL ACCESSORIES:

- Magnetic Crossbelts.
- Ceramic, and Rare Earth Magnetic Head Pulleys..
- Rare earth plate magnets mounted above the belts.
- Metal detectors with and without automatic contamination reject flip gates.
- Sacker stations for shredded and ground material.

Recycling Conveyors

Bale Break Stations

Bunting® bale break conveyors are designed to improve loading and separation efficiencies. They can be as simple as jogged in-feed conveyors for bales of plastic bottles or as complex so as to implement powered beater shafts to break up bales of plastic bottles. Whether it is bales of post-consumer detergent, milk jugs or plastic bottles, Bunting has bale break in-feed conveyors to feed your shredding line.

Bales of material are usually placed by fork lift on the in-feed portion of the conveyor either from the side or end loading. The operator then cuts and pulls the baling wire before proceeding to either jog or power feed the material onto the inclined shredder feeder conveyor.



- Heavy duty frame construction to withstand the toughest operating conditions.
- Heavy duty forklift loading and pullout slots.
- Conveyor frames for 30" to 72" wide belts.
- Adjustable belt speeds, ranging between 5 to 30 fpm.
- Optional double beater shafts for bottle applications.
- Available with small tables with forklift pullouts or large tables with stairs and working mezzanines.
- Live bottomed belted metering stations.
- Surge hoppers with live bottomed conveyors.
- Optional baling wire spindles available for operators to wrap material around on after cutting bale wires.
- Horizontal metering conveyors available for Gaylord dumpers.



DRAGSLIDE CONVEYORS



Designed for the thin mil plastic film industry to solve the problem of static electricity, Bunting's sealed Dragslide Conveyors are ideal for handling plastic film, paper, and fiber materials in the recycling industry.

- Dragslide conveyors feature a totally enclosed design, using UHMW drag flights to efficiently move and convey material.
- Sealed conveyor eliminates static conveying lines and results in a much cleaner facility.
- Reduces downtime as employees can focus on production instead of time-consuming clean-up and maintenance.
- Available in standard heavy duty units or larger max duty units, with floor supported or mobile bases depending on your production needs.
- In-feed hoppers designed to match up to shredder discharge points, allowing for seamless integration with your existing equipment.
- Optional rare earth magnet configurations, as well as optional metal detectors, are available to implement in discharge chute.
- Units equipped with clear sight windows, allowing operator to view material flow within the enclosed system.



HOCKEY-STICK STYLE INCLINED DRAGSLIDE CONVEYOR

Designed and built to match up to and fit up to shredder discharge openings. After receiving material from a shredder discharge opening, these inclined conveyors can then raise the material to the desired elevation, transfer material to another conveyor, or transfer material directly into an extruder.

HORIZONTAL DRAGSLIDE CONVEYORS

These conveyors work well for conveying film or fiber materials from one point to another in long horizontal runs. They are great transfer conveyors for a system which is moving free flowing materials and will keep your floor and shop area clean and neat.

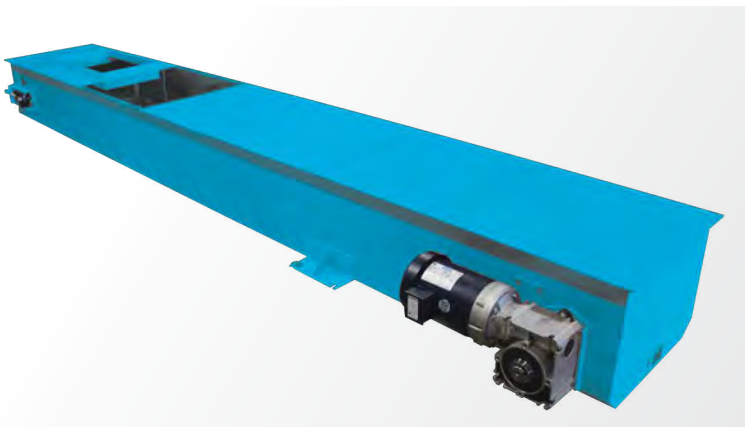

- Standard heavy duty units available for clean house conveying.
- Floor supported or mobile bases available based on your facility needs.
- In-feed hoppers designed to match up to shredder discharges.
- Clear sight windows for viewing material flow.
- Optional high-intensity (NHI) rare earth plate magnets available in discharge chutes.
- Optional metal detector available to be installed in discharge chute.
- UHMW flights allow for extended wear.

HISC® HIGH INTENSITY SEPARATION CONVEYORS®

The first of its kind in the industry, the Bunting® HISC® High Intensity Separation Conveyor® incorporates extremely high gauss fields, neodymium rare earth magnets, and a durable, field-tested design to achieve maximum stainless steel separation of small PET flake or ground plastic.

-
- Designed for extreme high-gauss fields of magnetic separation and removal of lightly magnetic tramp metal fines from plastics products. This ensures removal of even the smallest particles of contamination.
 - High-intensity fields also separate work-hardened 300 series stainless steel from the product stream, allowing for separation of metal contaminants that a standard magnetic separator would be unable to retrieve.
 - Tough urethane endless belts that resist wear and tear.
 - Designed i300 series stainless steel construction to comply with food grade regulations.

Features:

- 150mm pulley diameter. Standard widths run from 30cm to 170cm wide to match flow requirements.
- 2-ply urethane belt with 30mm flexwall and 12mm sweeper cleats on 400mm centres.
- 60-120 fpm variable speed with VFD depending on application.
- Heavy duty formed 5mm sideguard with flexwall belt to seal off and contain flow.
- Heavy duty formed 5mm frame construction with stainless steel frame and forklift lifting slots for installation.
- 20mm to -1 1/2 hp 3ph 60hz single or three phase motors.
- Can convey 500 to 1,500 lbs per foot/per hour depending on application.
- Splitter is adjustable to suit your goals for separation split and purity.

Optional Vibratory Feeder Accessory

- Provides uniform single-layer feeding for maximum separation efficiency. Highly recommended.
- Common sub-frame for Vibratory Feeder and HISC to set in place. Highly recommended.
- Customisable width and length to match applications.
- Comes complete with VFD controls and can be integrated into existing system.



MAGNETIC SEPARATION PULLEYS

Provides superior continuous removal and discharge of ferrous contamination, such as nails, staples, bolts and wire from conveyors. Bunting® Magnetic Separation Pulleys offer Maintenance-free operation.

- Manufactured for maximum reach-out, holding-force, and separation effectiveness.
- Available in both economical ceramic and high-intensity neo rare earth magnets for maximum separation.
- Pulleys are 100-400mm in diameter depending on your application needs. These pulley systems offer maintenance-free operation.
- Available in all-stainless-steel construction with food, sanitary, and USDA finishes available to fit your production safety regulations.



MAGNETIC CROSS-BELT CONVEYORS

Continuous over-conveyor separation for the recycling industry to remove ferrous materials from non-ferrous materials in plastics, wood, tire, metal and municipal scrap recycling.

- UHMW (ultra-high molecular-weight polyethylene plastic) wings extend over the edge of the belt to protect the edge of the belt from tramp metal tears and material getting under the belt.
- Available in both economical ceramic and high-intensity (NHI) rare earth magnets for maximum separation.
- Available in four sizes for different reach-out requirements.

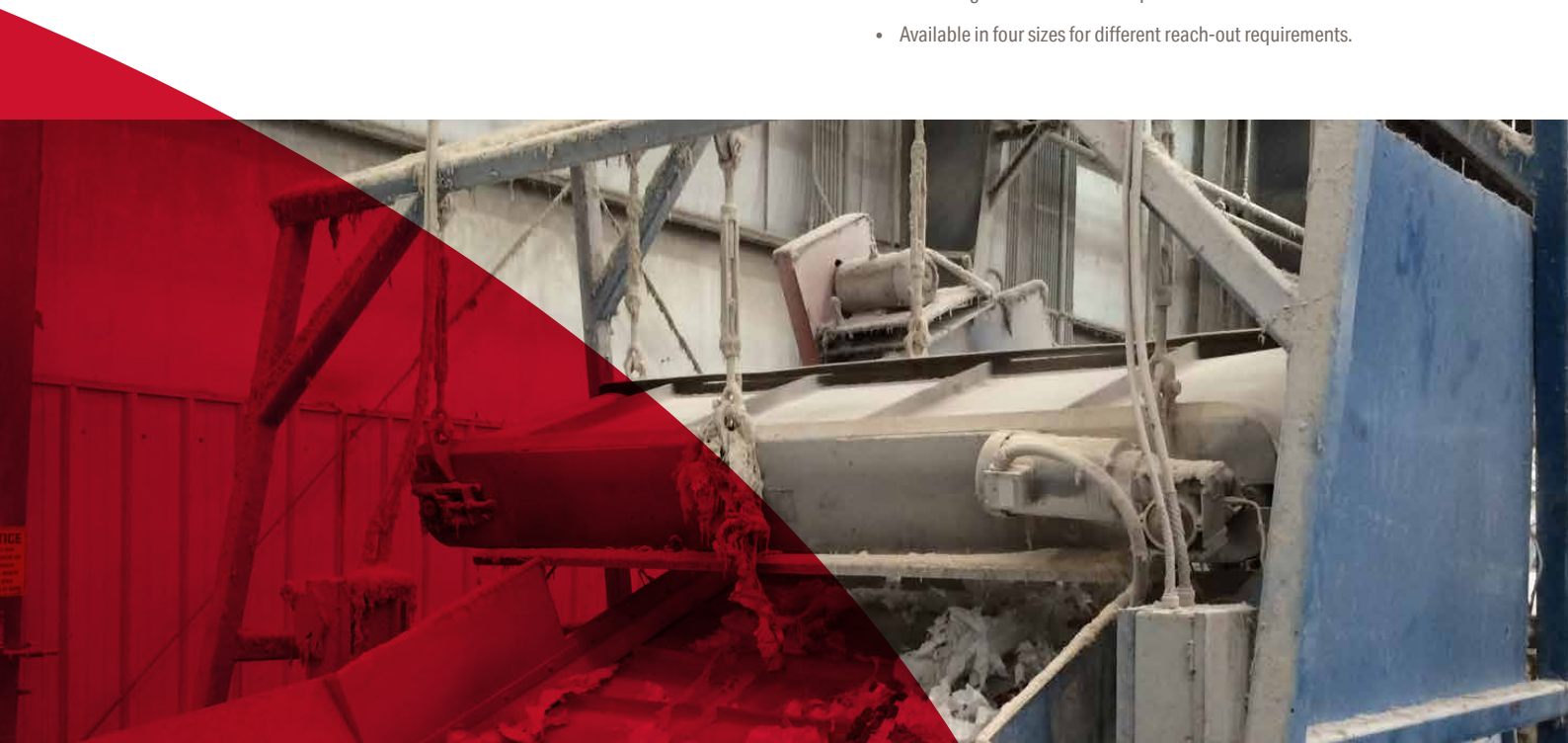

EDDY CURRENT SEPARATOR

The clean, low-profile Bunting® Eddy Current Separator uses Magnetic Finite Element Design to optimise the magnetic field, and maximise the focal point and strength of the gauss intensity. It is ideal for achieving maximum separation of small non-ferrous metals, such as aluminium chips, from shredded and ground plastic flake materials. The Bunting Eddy Current separates non-ferrous conductive metal from non-conductive recycled materials. This separation mechanic is used extensively in the plastics, municipal, electronics, glass, and metal recycling industries to separate shredded aluminium, aluminium cans, bottle caps, hard drive housings, and circuit board components into purer higher-value product and metal streams or PET purification. Through this engineering design and software technology, customers can achieve the cleanest plastic flake materials possible.

These units can also be designed into Bunting "custom systems" in combinations with transfer conveyors, magnetic drum separation feeders, high intensity magnetic separation conveyors, magnetic crossbelt conveyors, and vibratory feeder trays.

Bunting Engineers will provide 3D System CAD Models and 2D dimensional drawings for system review analysis when orders are placed.

- Designed to provide the optimal eddy current fields to achieve the maximum separation of small non-ferrous metals from other materials.
- Low maintenance conveyor with extremely tough urethane belts to allow longer wear.
- Cantilever frame weldment design allows easy slip off and on belt change within minutes.
- Double VFDs for optimising relative belt speeds.
- Available in four different widths with four rotor options available based on your application needs.



Optional Vibratory Feeder Accessory

- Uniform single-layer feeding for maximum separation efficiency.
- Customisable widths and lengths to match application requirements.
- Power supply and isolator designed to match flow requirements.
- Can be fabricated in either mild steel or stainless steel.
- Comes complete with controls and can be integrated into existing system.



PERFECT PLANT DIAGRAMS

Bunting® Perfect Plant diagrams showcase examples of ways to implement our equipment into your facility in order to create an ideal production environment. By installing our equipment at critical points in your process, you will maximise the quality and purity of your product by ensuring metal contaminants are removed from the greater product flow. Bunting's equipment protects the existing equipment in your facility, your customer, and your brand reputation. Bunting's Perfect Plants allow you to reap the benefits of an ideal production environment.

PERFECT PLASTICS PLANT

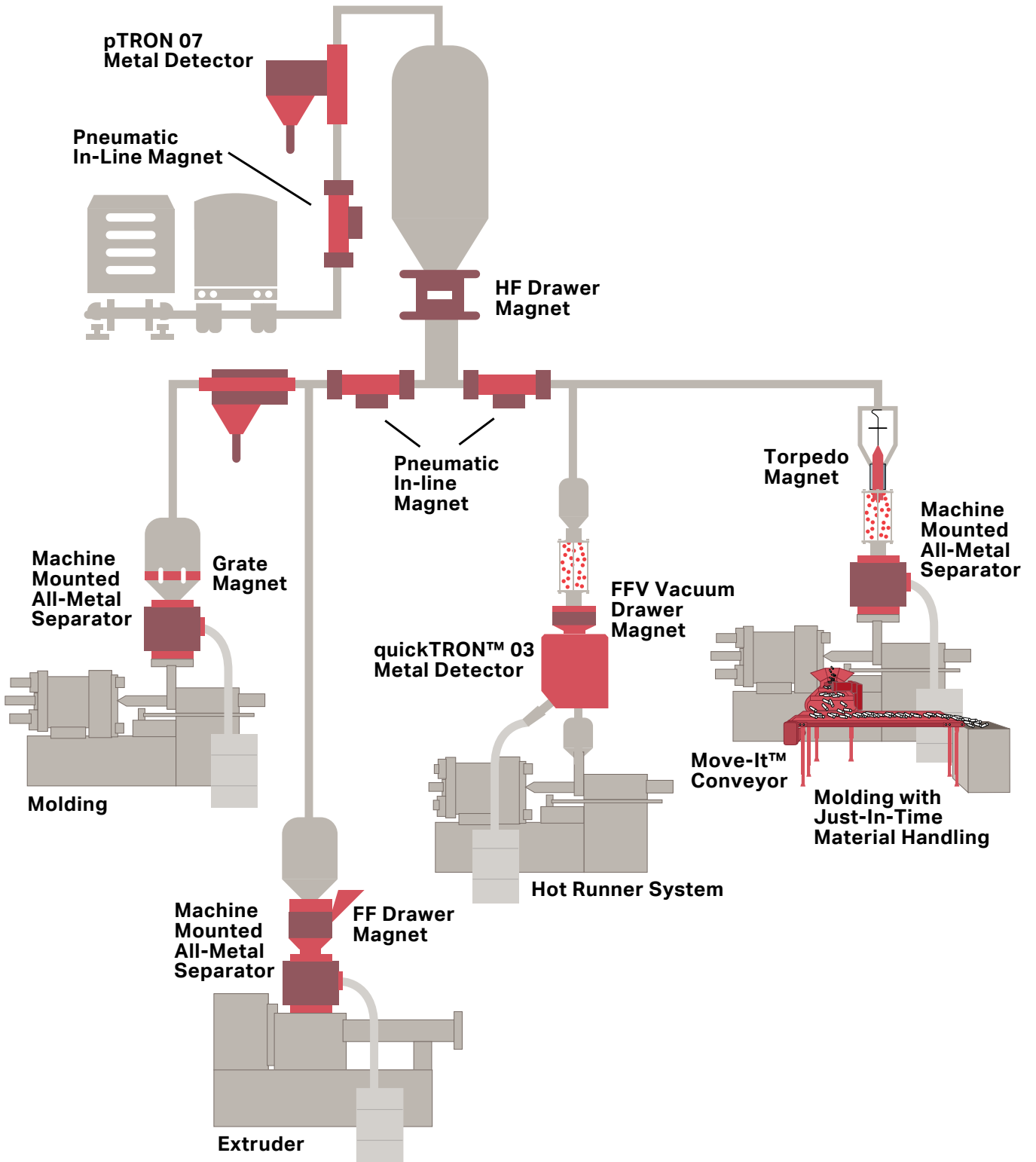

PERFECT PLASTICS PLANT

REGRIND

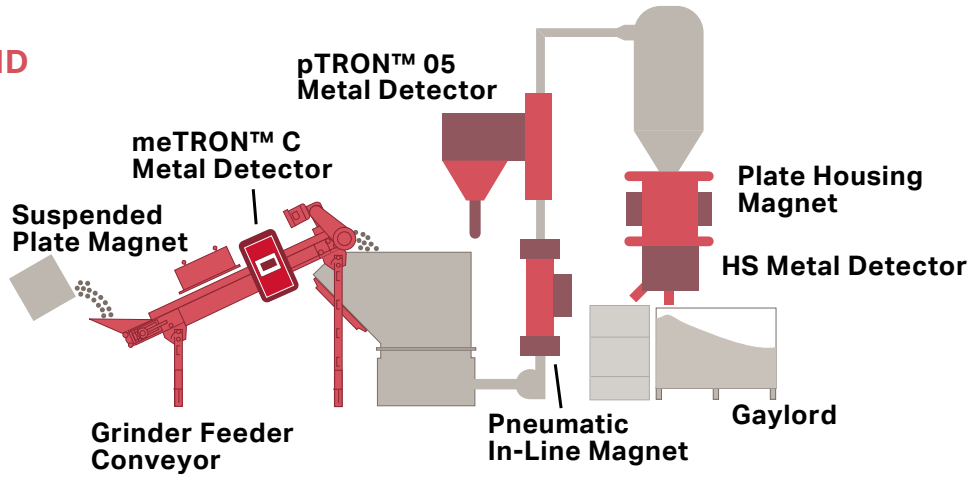

CLEANING STATION

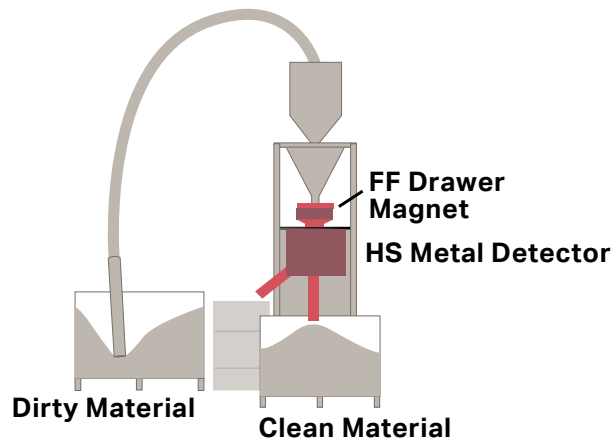

GAYLORD SYSTEM

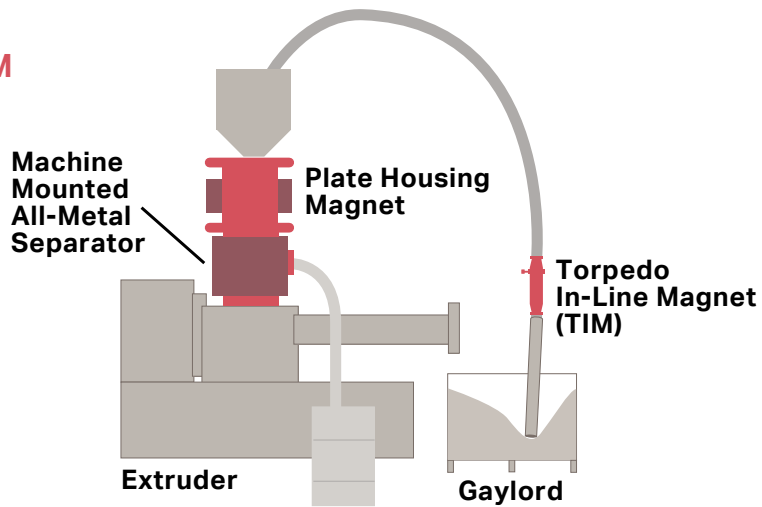

Pure success: What the Bunting name means to your plastics business.

Bunting is proud to provide innovative, custom-designed solutions for the plastics industry, as well as many other industries such as food, recycling, and mining. Our equipment is durable, dependable, and driven by the needs of our customers and the modern challenges they face. Bunting has been a family-owned, family-led company since 1959. Sixty years later, we have made massive strides in developing new technology to meet the unique needs of the 21st century, while remaining committed to delivering the highest quality products accompanied by excellent customer service.

We invite you to experience our customer service and products for yourself. Contact your Bunting representative today for more information to obtain a specific quote, or visit BuntingMagnetics.com.

GLOBAL. MAGNETIC. FORCE.™



Pure success: What the Bunting name means to your plastics business.

Bunting is proud to provide innovative, custom-designed solutions for the plastics, as well as many other industries such as food and pharmaceuticals, recycling, and aggregate, mining, and minerals industries. Our equipment is durable, dependable, and driven by the needs of our customers and the modern challenges they face. Bunting has been a family-owned, family-led company since 1959. Sixty years later, we have made massive strides in developing new technology to meet the unique needs of the 21st century, while remaining committed to delivering the highest quality products accompanied by excellent customer service.

We invite you to experience our customer service and products for yourself. Contact your Bunting representative today for more information or to obtain a specific quote.

Bunting - Berkhamsted
Northbridge Road,
Berkhamsted, Hertfordshire, HP4 1EH | UK
+44 (0)1442 875081
Email: Sales.Berkhamsted@BuntingMagnetics.com
www.Bunting-Redditch.com

Bunting - Newton
500 S. Spencer Road | P.O. Box 468
NEWTON, KS 67114 | USA
800.835.2526 | 316.284.2020
Fax: 316.283.4975
Email: Sales.Newton@BuntingMagnetics.com
www.BuntingMagnetics.com

GLOBAL. MAGNETIC. FORCE.™

Manufacturing & Distribution Locations:

Bunting - Newton
500 S. Spencer Road | P.O. BOX 468
Newton, KS 67114 | USA
Sales.Newton@BuntingMagnetics.com
800.835.2526 or 316.284.2020

Bunting - Elk Grove Village
1150 Howard Street
Elk Grove Village, IL 60007 | USA
Sales.ElkGroveVillage@BuntingMagnetics.com
800.232.4359 or 847.593.2060

Bunting - DuBois
12 Industrial Drive
DuBois, PA 15801 | USA
Sales.Dubois@BuntingMagnetics.com
1-800-437-8890 or 1-814-375-9145

Bunting - Berkhamsted
Northbridge Road,
Berkhamsted, Hertfordshire, HP4 1EH | UK
Sales.Berkhamsted@BuntingMagnetics.com
+44 (0)1442 875081

Bunting - Redditch
Burnt Meadow Road, North Moons Moat,
Redditch, Worcestershire, B98 9PA | UK
Sales.Redditch@BuntingMagnetics.com
+44 (0) 1527 -65858

Bunting - China
Nordic Industrial Park Co., Ltd.
A3 Building, 89 Jinchuann Road
Zhenhal, Ningbo 315221 | China
+86 (574) 86305971

BUNTING-REDDITCH.COM

©2020 BUNTING

2020 Plastics
020720-rev1